

COUVETTE / 1259

| CODICE | DESCRIZIONE | B (cm) | P (cm) | H (cm) | B (cm) | P (cm) | H (cm) |
|--------|-------------|------------------|--------|--------|-----------------|--------|--------|
| | | MISURA COPERTINA | | | MISURA CASSETTO | | |
| 1253 | 1 - Piccola | 20,8 | 20,7 | 5,2 | 20,3 | 15,3 | 4,1 |
| 1254 | 2 - Media | 22,2 | 25,7 | 5,2 | 21,7 | 20,3 | 4,1 |
| 1255 | 3 - Large | 32,2 | 25,6 | 5,2 | 31,7 | 20,2 | 4,1 |
| 1259 | 4 - Xlarge | 32,2 | 32,6 | 5,2 | 31,7 | 27,2 | 4,1 |

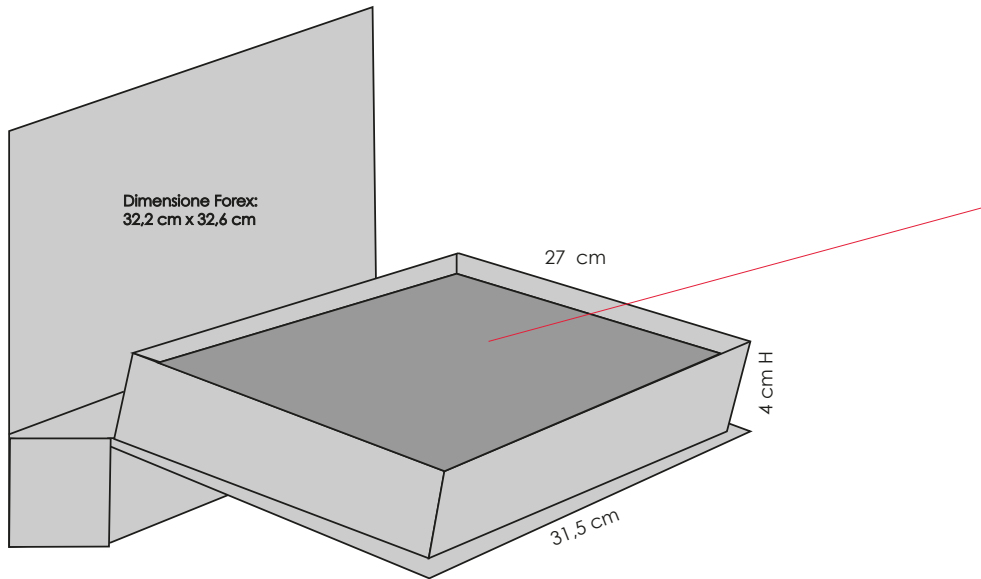

CODICE 1259

4 - XLarge

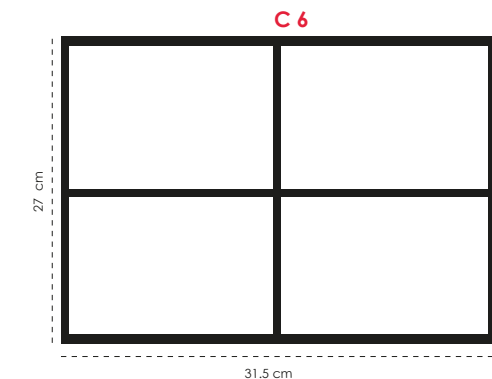
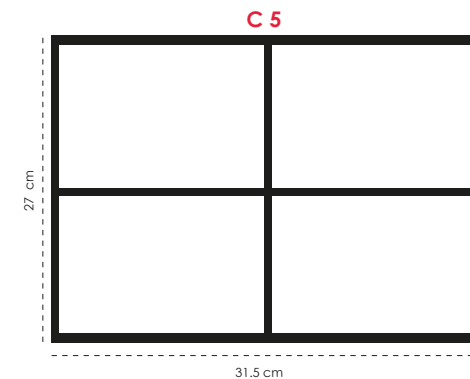
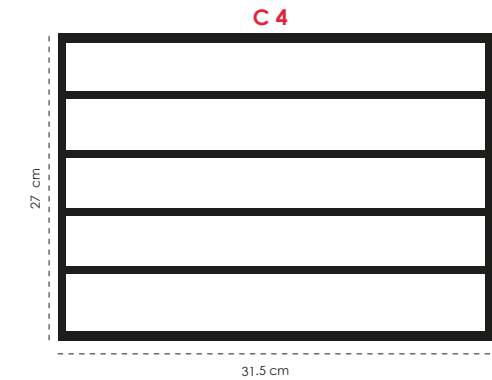
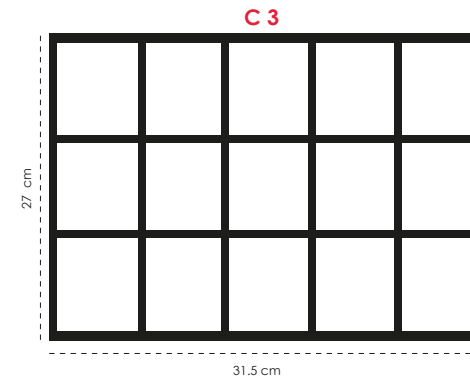
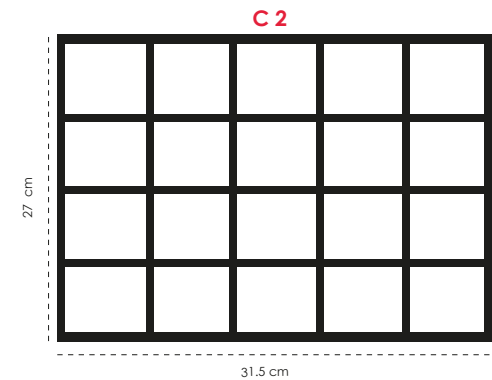
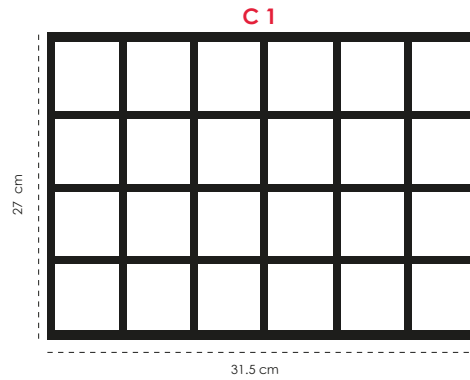

INTERNI

